

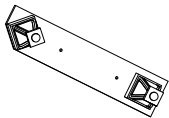

LOBERON

COMING HOME

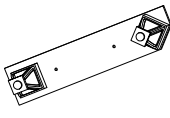
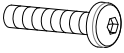

<p>Ax1</p> 	<p>Bx1</p> 	<p>Cx1</p> 	<p>Dx4</p>  <p>M6x30</p>	<p>Ex4</p>  <p>Φ6.5,φ14</p>	<p>Fx1</p> 
--	--	--	---	--	--

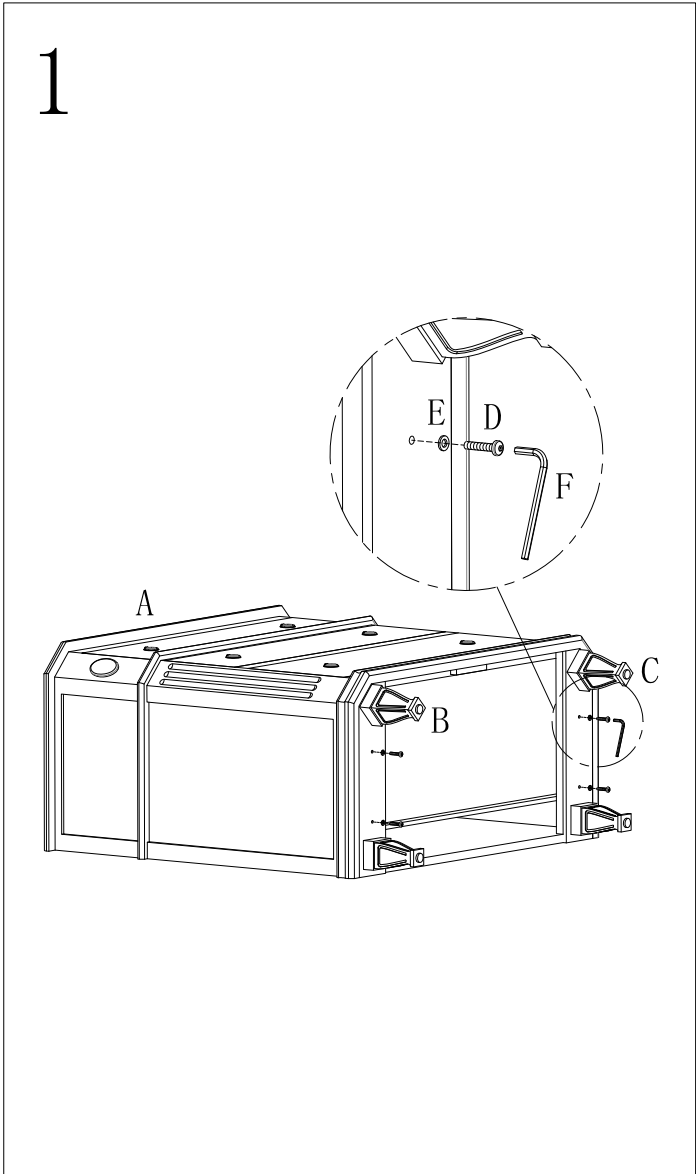

LOBERON

COMING HOME

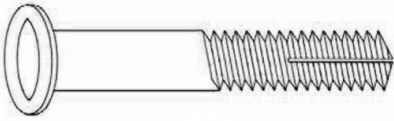
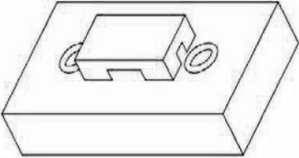
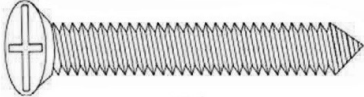
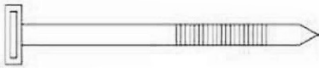

<p>A M8*41</p>  <p>X4</p>	<p>B 45*19*9</p>  <p>X2</p>
<p>C M4*30</p>  <p>X4</p>	<p>D M11*L245</p>  <p>X2</p>

